

SHINOLA WATCHES

SIZING GUIDE

We created this printable sizing guide to help you judge the scale of our watches on your wrist.

Print this template on an 8.5" x 11" piece of paper at 100% and cut out your preferred size.



RULER TO SCALE FOR REFERENCE

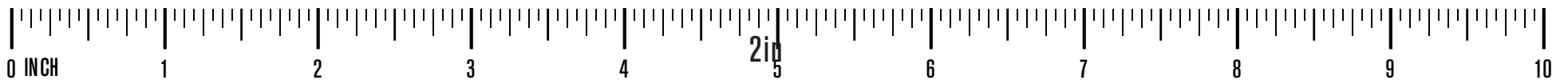

THE RUNWELL

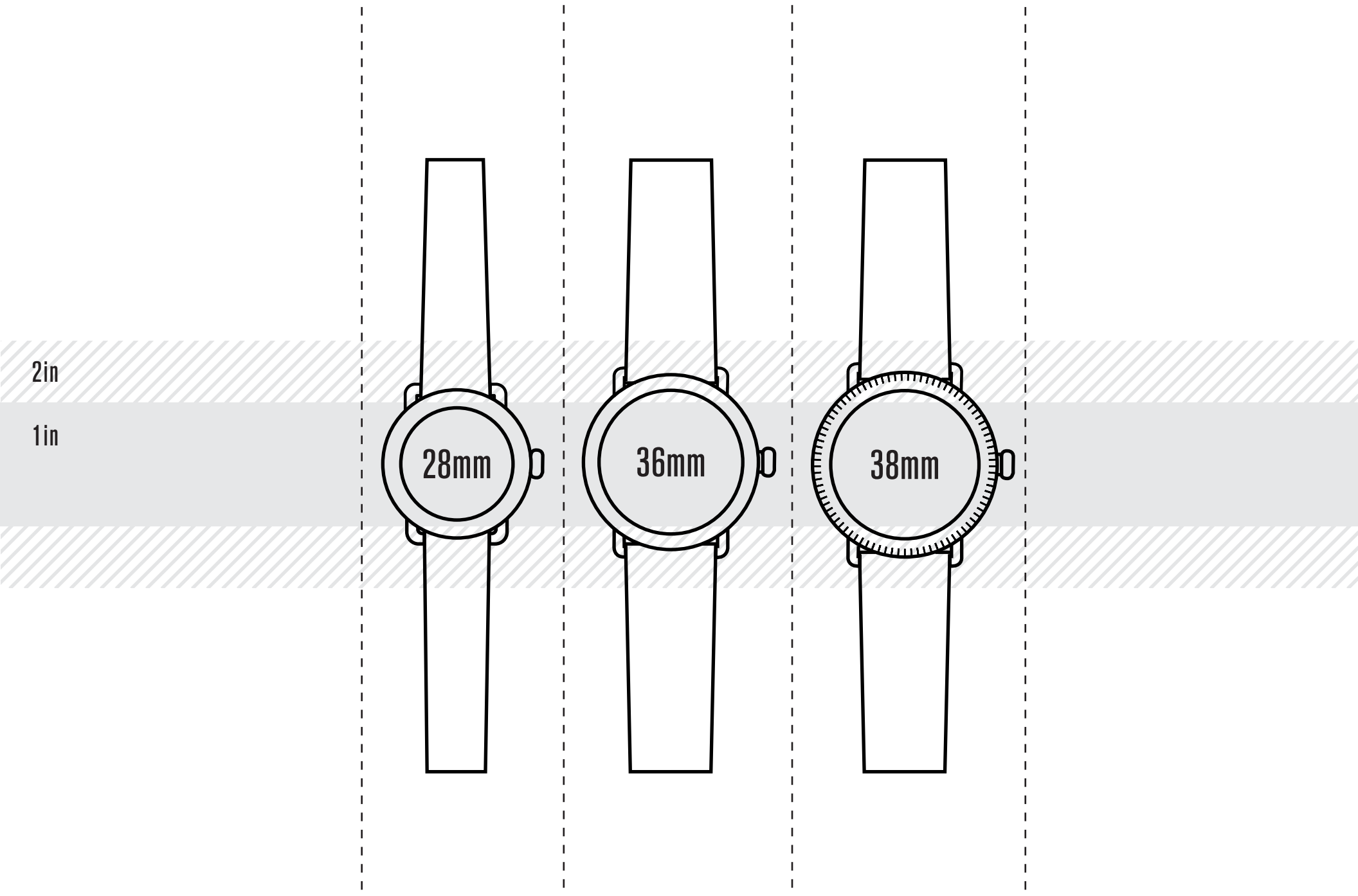

THE RUNWELL

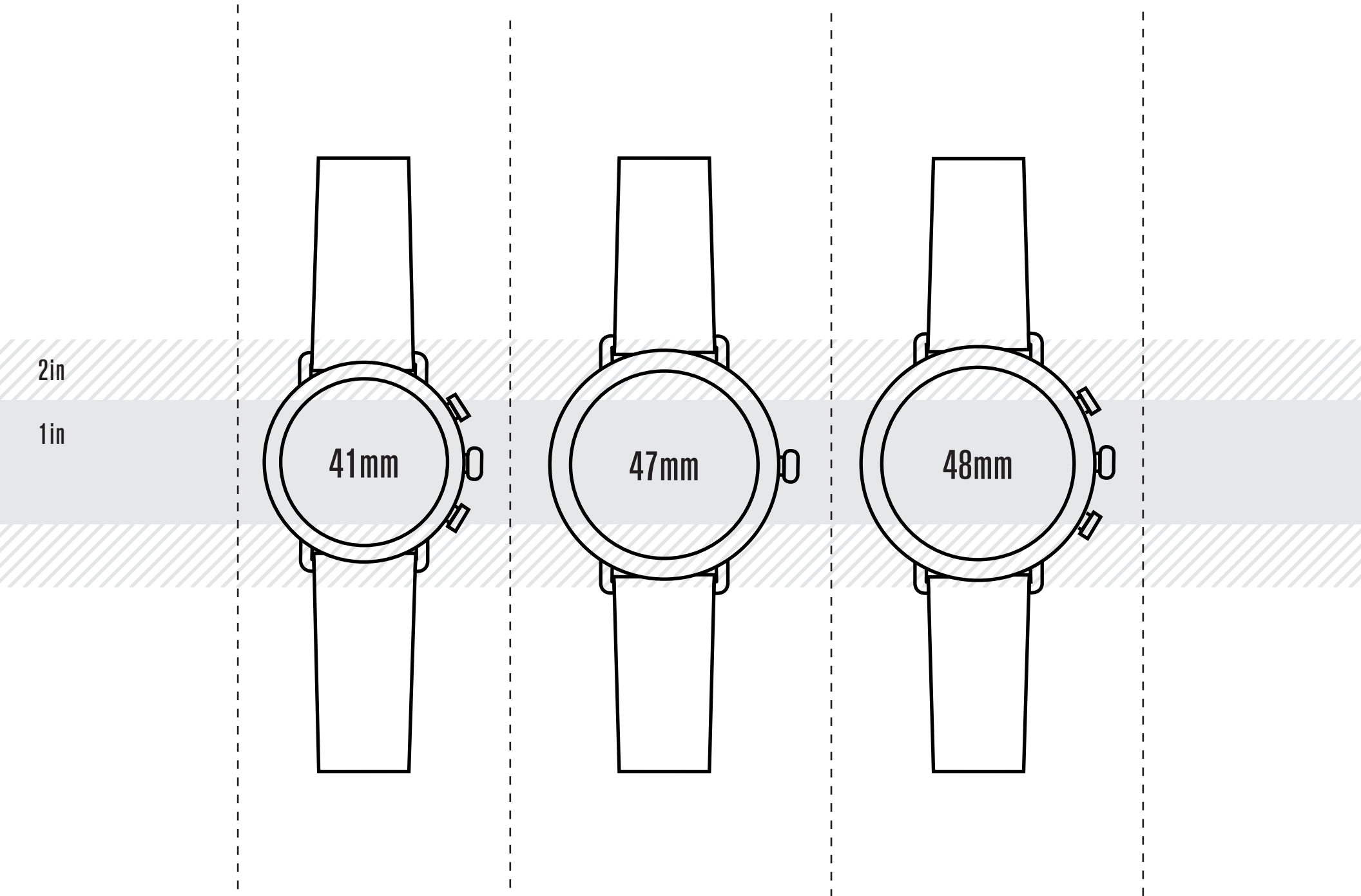

2in

1in

41mm

47mm

48mm

THE CASS

THE BIRDY

THE RAMBLER

THE BEDROCK

THE BOLT

2in

1in

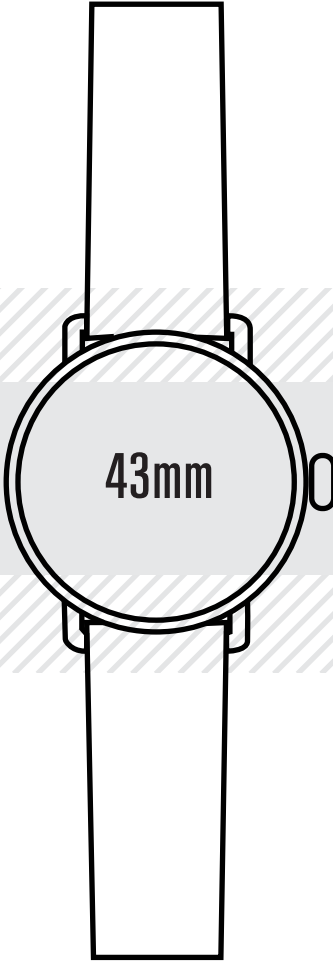
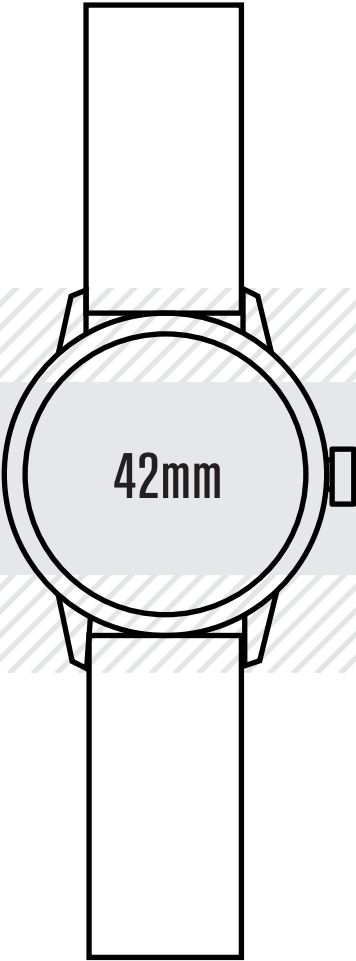
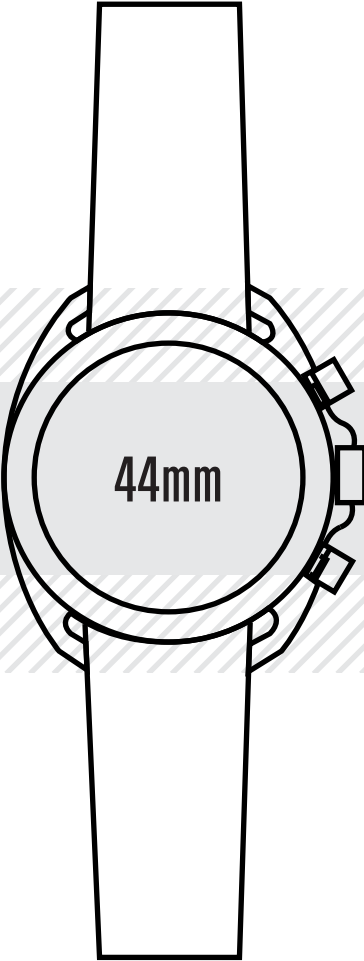
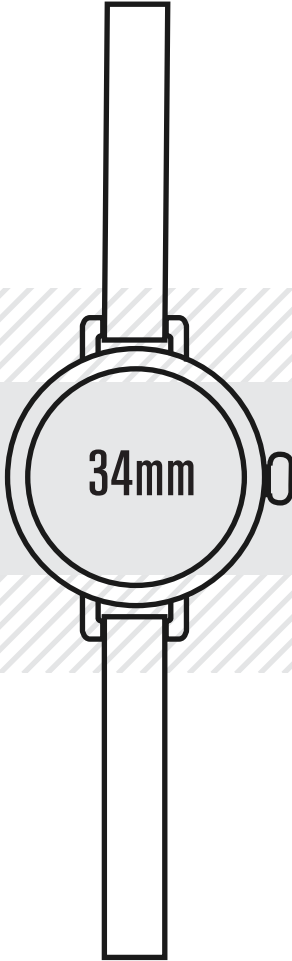
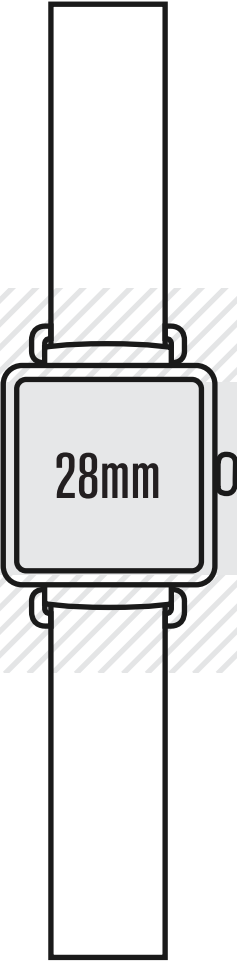

THE CANFIELD

THE GUARDIAN

